

CAD FILE:

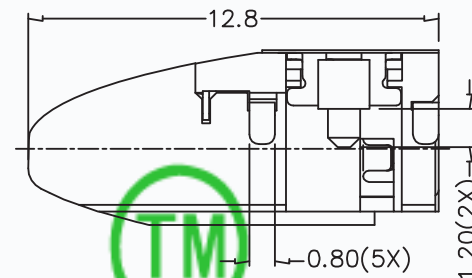
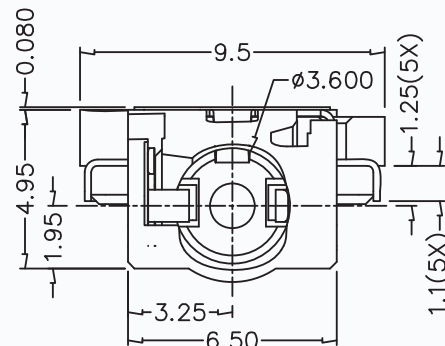
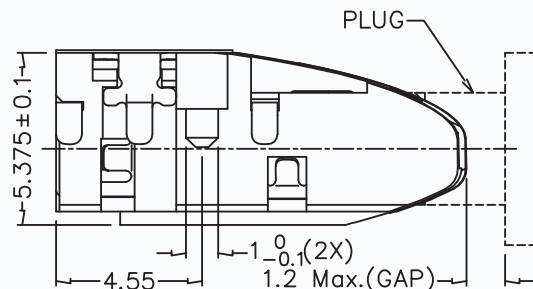
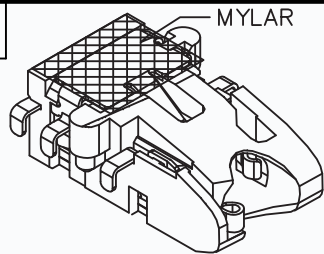

CMTDDZ

*** MATERIAL**

- TERMINAL 1 : COPPER ALLOY
- TERMINAL 2 : COPPER ALLOY
- TERMINAL 3 : COPPER ALLOY
- TERMINAL 4 : COPPER ALLOY
- TERMINAL 5 : COPPER ALLOY
- HOUSING : PA10T
- MYLAR : POLYIMIDE

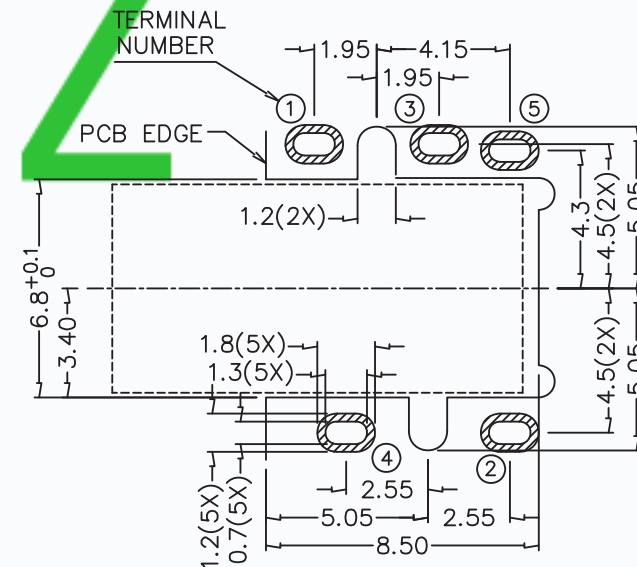
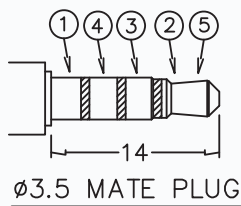
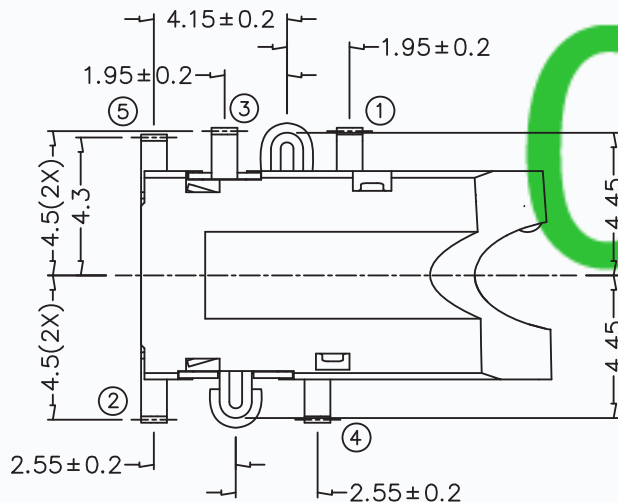
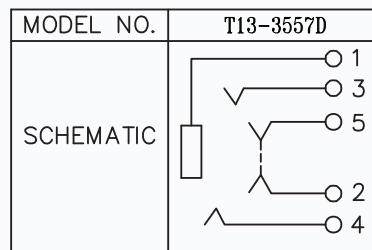

RECOMMENDED PCB LAYOUT
TOLERANCE: ±0.05
(TOP VIEW)

APPD.	DESCRIPTIONS OF REVISION

**TOLERANCE
UNLESS SPECIFIED**

WITHIN 1.5mm : ±0.1mm
OVER 1.5mm : ±0.2mm

THESE DRAWINGS AND SPECIFICATIONS ARE THE PROPERTY OF DONGGUAN TIANDU ELECTRONICS CO.,LTD. AND SHALL NOT BE REPRODUCED, COPIED OR USED IN ANY MANNER WITHOUT THE PRIOR WRITTEN CONSENT OF DONGGUAN TIANDU ELECTRONICS CO., LTD.

TITLE : 3.5mm PHONE JACK

MODEL: T13-3557D

CMTDDZ 东莞市田都电子有限公司
DONGGUAN TIANDU ELECTRONICS CO.,LTD.

UNIT : mm	DRWG NO.: CMTDDZ-T13-3557D-00
SCALE: 3:1	DWN. ERIC 2013-6-17
CHK'D MAIKO 2013-6-17	APPD. Coco 2013-6-17